

A Study of Finite Difference Approximations to Steady-State, Convection-Dominated Flow Problems

WEI SHYY

*General Electric Corporate Research and Development,
P.O. Box 8, Schenectady, New York 12301*

Received July 14, 1983; revised December 6, 1983

Five different finite difference schemes, first-order upwind, skew upwind, second-order upwind, second order central differencing, and QUICK, approximating the convection terms in the transport equation with fluid motion, have been studied. Three simple test problems are used to compare the performances by the five schemes for high cell Peclet number flows; they are also used to demonstrate the restraints on the accuracy of the numerical approximations set by the types of the boundary conditions, by the presence of the source term in the flow region, and by the skewness of the numerical grid lines. The basic reasons behind the spurious oscillations in a numerical solution are studied. Among all five schemes studied, the second-order upwind is found to be, in general, the most satisfactory. © 1985 Academic Press, Inc.

1. INTRODUCTION

The development of numerical methods for solving the transport equations with convection-dominated fluid motion has been a subject of concern for more than two decades. For the shear layer flows, numerical predictions are now well established. There are a number of accurate numerical procedures which have been shown to be successful, and most of the difficulties associated with such predictions relate directly to the lack of total physical understanding and consequent inadequacies in the various turbulence models used. However, in the case of complex flows which fail to satisfy the boundary layer approximation, and which are in general elliptic, the situation is not so clear. The accuracy of a numerical prediction for this kind of problem rests not only on the accuracy of the physical model but, even more basically, on the accuracy of the numerical techniques used to solve the equations which embody the model. The desire to use higher-order approximations and small mesh sizes to ensure accuracy must be balanced against limitations imposed by the complexity of the problem being solved, the availability of the computing equipment, and the stability of the solution algorithm.

Early attempts using the second-order central difference approximation to the terms in the governing equations representing convection failed to produce wiggle-free solutions for high values of the Reynolds (or Peclet) number [1, 2]. It was found that these wiggles could be eliminated by using one-sided (upwind) first-

order finite difference approximations to the derivatives in the convection terms. Solutions for high Reynolds number flow have been published by many investigators, e.g., [3–15]. It is recognized that first-order upwind difference approximations can generate significant truncation errors. The most serious one is the production of a diffusive effect which augments the effects of viscosity; this numerical diffusion in elliptic flows plagues the computational fluid mechanician. For example, in the pioneering work by Allen and Southwell [5] the first-order upwind approximation was employed in a vorticity-stream function solution to the Navier–Stokes equations for viscous flow around a cylinder; the results show that the downstream eddies are too short and they vary very little between $Re = 100$ and 1000 on a coarse mesh.

deVahl Davis and Mallinson [6] pointed out that when the velocity vector is more than marginally skewed relative to the numerical grid lines and the so-called cell Peclet number, $|p_{e, \Delta x}| (= |\mathbf{V}| \Delta X / \nu)$, where \mathbf{V} is a relevant fluid velocity, ΔX is the mesh width, and ν is the physical diffusivity for the transported quantity), significantly exceeds unity in regions where diffusive transport normal to the flow direction is important, this error may become so dominant as to obscure the effects of physical diffusivity on the flow. Also, Castro [7] showed that in regions of complex flow, particularly near sharp corners, the size of the truncation error associated with the first-order upwind scheme cannot easily be reduced to insignificance, but the errors may be simply convected downstream leading to poor predictions over the rest of the flow field.

In addition, Raithby [8] and Leonard [9] have shown that in the presence of source terms, large errors may result from the first-order upwind solutions for a convection-dominated flow. These conditions may prevail in the case of recirculating flows in general and turbulent ones in particular.

The alternative is to use more complex and sophisticated discretization methods for convection. Several schemes are currently available. One such method, proposed by Raithby [10], is termed skew upwind differencing. The skew upwind differencing scheme, although like the conventional upwind scheme formally only first-order accurate, yields a significant reduction in numerical diffusion by taking the direction of the velocity vector into account. Another method, proposed by Leonard [9], is called QUICK (Quadratic Upstream Interpolation for Convective Kinematics). The QUICK scheme is based on the use of upstream-shifted parabolic interpolation for every control volume surface on the computational grids and is free from (the second-order) numerical diffusion. Both skew upwind and QUICK have been examined by Leschziner [11] and by Leschziner and Rodi [12] for some idealized cases as well as for unconfined recirculating flows. The schemes are found to be superior to the conventional upwind simulation for the cases they studied. However, the solutions obtained by using both formulations have shown under- and over-shoots. It should also be noted that the skew upwind scheme does not resolve the difficulties associated with the source term when applying the first-order upwind approximations; Leonard [9] has shown that QUICK does give good resolution in the presence of the source term.

Another finite difference approximation which has attracted comparatively little attention was the one used by Atias *et al.* [14]. They studied a second-order upwind scheme for discretizing the convection terms in the vorticity transport equation and found that it has the potential of yielding sufficient accuracy. No systematic study has been done for this scheme as yet, but Gupta and Manohar [15] gave unfavorable comments on the grounds of a von Neumann-type analysis.

The difficulty of a numerical simulation is further compounded by the fact that for cell Reynolds number $Re \Delta x$ greater than unity, difference schemes of higher-order formal accuracy do not necessarily promise smaller total error. Cheng and Shubin [16] studied the one-dimensional, steady-state Burgers equation. They found that the error in computational results with formally second-order accurate algorithms and coarse meshes varies widely, and does not increase as Δx^2 or $(Re \Delta x)^2$. Furthermore, the first-order accurate algorithm can provide essentially the same solutions as do some of the second-order algorithms; such results can be either better or worse than those offered by other formally second-order schemes. Thus, they concluded that the formal order of accuracy of a difference algorithm may not reflect the magnitude of computational errors for large $Re \Delta x$. Stubbley *et al.* [17] demonstrated that it is not just the error introduced in the approximation of local function values or gradients by a particular discretization scheme which is important, but also the nature of the way this local error is propagated by the discretized version of the convection and diffusion terms in the differential equation.

In this study, attempts have been made to clarify some of the ambiguities cited above associated with the numerical simulations of a high cell Peclet number complex flow problem as well as to find a comparatively accurate finite difference scheme to get the final solution of a discretized equation. The restraints set by the size of the cell Peclet number on the effectiveness of a given finite difference scheme is studied first. The accuracy of a finite difference approximation to an idealized flow problem in the presence of the source term is then analyzed. Comparisons are made by studying the solutions by different schemes for the test problems. The effects of numerical diffusion due to the inclination of the computational grid lines in a multidimensional flow field are also compared among different schemes. The influences of the different boundary conditions on the mathematical accuracy and on the physical reality in the numerical solutions are examined. One objective here is to shed some light on the relative merits of several schemes and to contrast their performances under both mild and stringent flow conditions. Five different finite difference schemes approximating the convection terms are analyzed: first-order upwind, skew upwind, second-order central differencing, second-order upwind, and QUICK. Test cases are chosen to be simple but also to contain the most relevant information.

2. NUMERICAL PROCEDURES

In what follows, exclusive use of the second-order central differencing will be adopted to approximate the diffusion terms in the governing equation, e.g.,

$$\left. \frac{\partial^2 \phi}{\partial x^2} \right|_{i,j} = \frac{\phi_{i+1,j} - 2\phi_{i,j} + \phi_{i-1,j}}{\Delta x^2} + T_d, \quad (1)$$

where T_d is the truncation error resulting from replacing the diffusion term with the finite difference approximation; the notation used in Eq. (1) is shown in Fig. 1.

As to the finite difference approximation to the convection terms, the following schemes will be considered and tested:

(a) first-order upwind

$$\begin{aligned} \left. \frac{\partial(u\phi)}{\partial x} \right|_{i,j} &= \frac{u_{i,j}\phi_{i,j} - u_{i-1,j}\phi_{i-1,j}}{\Delta x} + T_c, & \text{for } u > 0, \\ &= \frac{u_{i+1,j}\phi_{i+1,j} - u_{i,j}\phi_{i,j}}{\Delta x} + T_c, & \text{for } u < 0, \end{aligned} \quad (2)$$

where T_c is the truncation error inherent in replacing the convection term with the finite difference approximation.

(b) second-order central differencing

$$\left. \frac{\partial(u\phi)}{\partial x} \right|_{i,j} = \frac{u_{i+1,j}\phi_{i+1,j} - u_{i-1,j}\phi_{i-1,j}}{2\Delta x} + T_c. \quad (3)$$

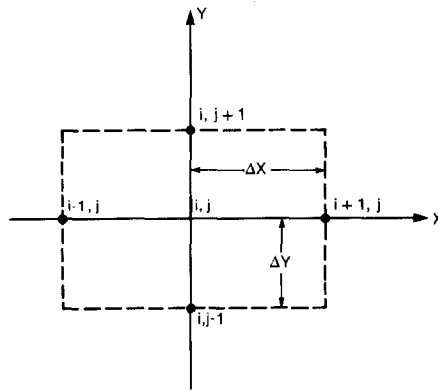

FIG. 1. Notation used in a computational mesh.

(c) second-order upwind

$$\begin{aligned} \left. \frac{\partial(u\phi)}{\partial x} \right|_{i,j} &= \frac{1}{2\Delta x} (3u_{i,j}\phi_{i,j} - 4u_{i-1,j}\phi_{i-1,j} + u_{i-2,j}\phi_{i-2,j}) + T_c, & \text{for } u > 0, \\ &= \frac{1}{2\Delta x} (-u_{i+2,j}\phi_{i+2,j} + 4u_{i+1,j}\phi_{i+1,j} - 3u_{i,j}\phi_{i,j}) + T_c, & \text{for } u < 0. \end{aligned} \tag{4}$$

(d) QUICK

$$\begin{aligned} \left. \frac{\partial(u\phi)}{\partial x} \right|_{i,j} &= \frac{1}{\Delta x} \left(\frac{3}{8}u_{i+1,j}\phi_{i+1,j} + \frac{3}{8}u_{i,j}\phi_{i,j} - \frac{7}{8}u_{i-1,j}\phi_{i-1,j} \right. \\ &\quad \left. + \frac{1}{8}u_{i-2,j}\phi_{i-2,j} \right) + T_c, & \text{for } u > 0, \\ &= \frac{1}{\Delta x} \left(-\frac{1}{8}u_{i+2,j}\phi_{i+2,j} + \frac{7}{8}u_{i+1,j}\phi_{i+1,j} - \frac{3}{8}u_{i,j}\phi_{i,j} \right. \\ &\quad \left. - \frac{3}{8}u_{i-1,j}\phi_{i-1,j} \right) + T_c, & \text{for } u < 0. \end{aligned} \tag{5}$$

As to the skew upwind differencing, it reduces to the original first-order upwind scheme in a one-dimensional problem. For a multi-dimensional flow problem, it can reduce the numerical diffusion by taking the direction of the velocity vector into account, and this will be studied later on.

The SOR type of iterative method is used to obtain the convergent solutions for all test cases. The relaxation factor may be larger or smaller than 1, depending upon the scheme used and the value of cell Peclet number, as discussed in [24].

3. NUMERICAL ACCURACY AND CELL PECLLET NUMBER

It is well known by now that numerical schemes (to any finite degree of accuracy) introduce numerical diffusion and dispersion in roughly the same way as physical diffusion and dispersion in phenomena of fluid flow [18, 19]. This may be examined by expanding the finite difference equation in Taylor series to get the original differential equation plus higher-order terms which represent the truncation errors introduced in the course of approximation. The resulting equation is called the modified equation. Table I shows the coefficients of the first six derivatives in the modified equation

$$u\phi_x + q\phi_{xxx} + r\phi_x^{(5)} = d\phi_{xx} + e\phi_x^{(4)} + f\phi_x^{(6)} + \text{HOT}, \tag{6}$$

where HOT represents the higher-order terms in Taylor series, derived by the combination of one of the finite difference approximations discussed in Eqs. (2) to (5) to the convection term and Eq. (1) to the diffusion term of the one-dimensional, steady-state linear Burgers equation

$$u\phi_x = v\phi_{xx}, \quad u, v = \text{constants} > 0. \tag{7}$$

TABLE I
Coefficients in Eq. (6) for Approximating Eq. (7) by Four Different Schemes

Method	u	q	r	d	e	f
First-order upwind	u	$\frac{u \Delta x^2}{6}$	$\frac{u \Delta x^4}{120}$	$v + \frac{u \Delta x}{2}$	$\frac{v \Delta x^2}{12} \left(\frac{p_e \Delta x}{2} + 1 \right)$	$\frac{v \Delta x^4}{360} \left(\frac{p_e \Delta x}{2} + 1 \right)$
Second-order upwind	u	$-\frac{u \Delta x^2}{3}$	$-\frac{7u \Delta x^4}{60}$	v	$\frac{v \Delta x^2}{12} (-3p_e \Delta x + 1)$	$\frac{v \Delta x^4}{360} (-15p_e \Delta x + 1)$
Second-order central	u	$\frac{u \Delta x^2}{6}$	$\frac{u \Delta x^4}{120}$	v	$\frac{v \Delta x^2}{12}$	$\frac{v \Delta x^4}{360}$
QUICK	u	$\frac{u \Delta x^2}{24}$	$\frac{11u \Delta x^4}{480}$	v	$\frac{v \Delta x^2}{12} \left(-\frac{3p_e \Delta x}{4} + 1 \right)$	$\frac{v \Delta x^4}{360} \left(-\frac{15}{4} p_e \Delta x + 1 \right)$

TABLE II
 Values of α and β in Eq. (9) by Substituting the Fourier Component of Wavenumber $k = \pi/\Delta x$

Method	α	β
First-order upwind	-0.83	$0.23 p_{e \Delta x} - 0.55$
Second-order upwind	-8.07	$-1.59 p_{e \Delta x} - 0.55$
Second-order central	-0.83	-0.55
QUICK	1.82	$-0.40 p_{e \Delta x} - 0.55$

If we expand the dependent variable ϕ in Eq. (6) as a Fourier series in the x -direction, we obtain

$$\phi = \sum_{j=-\infty}^{\infty} a_j e^{ik_j x} \tag{8}$$

The Fourier component of the shortest wavelength resolved by a finite difference mesh is of wavelength $l = 2 \Delta x$. The corresponding wavenumber is $k_{\max} = \pi/\Delta x$. The longest wavelength is $l_{\max} = L$, which is the total length spanned by the meshes. The corresponding minimum wavenumber is $k_{\min} = 2\pi/L$. If one substitutes a Fourier component $\phi_j = a_j e^{ik_j x}$ into Eq. (6), then one can easily find that all the schemes in Table I except the first-order upwind give good approximations to Eq. (7) for $k = k_{\min}$ with the errors proportional to $1/N^2$ ($L = N \Delta x$). On the other hand, for $k = k_{\max}$, no scheme can yield reasonable accurate approximations. This may be seen from Table II, which shows the values of α and β for the Fourier components with $k = k_{\max}$, for the various schemes, where

$$\alpha = \frac{q\phi_{xxx} + r\phi_x^{(5)}}{u\phi_x} \tag{9a}$$

$$\beta = \frac{(d - \nu)\phi_{xx} + e\phi_x^{(4)} + f\phi_x^{(6)}}{v\phi_{xx}} \tag{9b}$$

All the values of α and β are at least of the order of unity; in the region where those high-wavenumber Fourier components are important for the solution, the numerical diffusion and dispersion are by no means negligible. Furthermore, this difficulty cannot be resolved by using formally a higher-order scheme.

For a high Peclet number flow problem the convection terms are dominant in the main part of the flow domain; the real solution might vary rapidly in some thin regions where the convection terms are balanced by the diffusion terms due to, for example, the restraint imposed by the boundary conditions. Hence, in a numerical viscous flow simulation the mesh size should be fine enough so that the ratio of $u\phi_x/(v\phi_{xx})$ in Eq. (7) is of the order of unity, at least at the highest resolvable

wavenumber, $k = k_{\max} = \pi/\Delta x$. If the ratio is much larger than one, then the convection term can never be balanced by the viscous term in all the numerically resolvable scales. If a Fourier component $\phi_j = a_j e^{ik_j x}$ is substituted into $u\phi_x/(v\phi_{xx})$ and $k_j = k_{\max}$ is used, then as pointed out by MacCormack and Lomax [20], the condition for a unity ratio between the convection and the diffusion terms is

$$p_e \Delta x = \frac{u \Delta x}{v} = O(1). \quad (10)$$

At high Peclet numbers, the mesh size cannot, with present computers, be made fine enough to fulfill this condition. The viscous diffusion at wavenumbers higher than those resolved by the numerical approximation must be accounted for through modeling. Hence, a suitable finite difference scheme for a high Peclet number flow will be one that maintains good accuracy in the convection-dominated region; in the regions where the convection terms and the viscous terms in the original differential equation should balance each other, which cannot be done exactly numerically, the truncation error should enhance the weight of the viscous terms. By doing this, though the fine structure of the real solutions cannot be resolved due to the large error introduced in the high-wavenumber components part, the results obtained from the numerical approximation are, in general, physically correct and useful; the disturbances arising from an inaccurate numerical simulation in a thin layer can be damped out without propagating into the main region. As will be shown later on, the truncation error of a given finite difference scheme may or may not be able to increase the viscous effects where needed. Hence, a formally higher-order scheme does not necessarily perform better for the high cell Peclet number problems, due to the inadequate resolution to the rapidly varying solution in the thin layers.

4. ONE-DIMENSIONAL TEST PROBLEMS

Test Problem I: Boundary Layer Type Flow

Equation (7) with the boundary conditions $\phi = 0$ at $x = 0$ and $\phi = 1$ at $x = 1$ is considered here. The exact solution of this problem is

$$\phi(x) = \frac{1 - e^{p_e x}}{1 - e^{p_e}}, \quad (11)$$

where $p_e = u1/v$ is the Peclet number. For small to moderate p_e , $\phi(x)$ displays a solution which varies rather smoothly throughout the entire domain. However, as p_e is increased much larger beyond unity, the solution becomes one of boundary layer type in that $\phi(x)$ is virtually zero except in the region near $x = 1$, within a thin layer of thickness $\delta \cong 1/p_e$ wherein the entire variation in the solution is contained in this layer; upstream of this boundary layer, the flow is entirely convection dominated.

TABLE IIIa
 Numerical Solutions to Test Problem I
 (Number of Grid Points = $N + 1 = 11$, $p_{e, dx} = 0.2$)

Method	ϕ_1	ϕ_2	ϕ_3	ϕ_4	ϕ_5	ϕ_6	ϕ_7	ϕ_8	ϕ_9	ϕ_{10}	ϕ_{11}
Eq. (11)	0	3.47 <i>E-2</i>	7.70 <i>E-2</i>	0.129	0.192	0.269	0.363	0.478	0.619	0.790	1.00
First-order upwind	0	3.85 <i>E-2</i>	8.48 <i>E-2</i>	0.140	0.207	0.287	0.383	0.498	0.636	0.801	1.00
Second-order upwind	0	3.58 <i>E-2</i>	7.88 <i>E-2</i>	0.131	0.195	0.272	0.367	0.482	0.622	0.792	1.00
Second-order central	0	3.45 <i>E-2</i>	7.67 <i>E-2</i>	0.128	0.191	0.268	0.362	0.477	0.618	0.790	1.00
QUICK	0	3.53 <i>E-2</i>	7.77 <i>E-2</i>	0.129	0.193	0.270	0.364	0.479	0.619	0.791	1.00

TABLE IIIb
 Numerical Solutions to Test Problem I (11 Grid Points, $p_{e, dx} = 10.0$)

Method	ϕ_1	ϕ_2	ϕ_3	ϕ_4	ϕ_5	ϕ_6	ϕ_7	ϕ_8	ϕ_9	ϕ_{10}	ϕ_{11}
Eq. (11)	0	8.19 <i>E-40</i>	1.80 <i>E-35</i>	3.98 <i>E-31</i>	8.76 <i>E-27</i>	1.93 <i>E-22</i>	4.25 <i>E-18</i>	9.36 <i>E-14</i>	2.06 <i>E-9</i>	4.54 <i>E-5</i>	1.00
First-order upwind	0	3.90 <i>E-10</i>	4.65 <i>E-9</i>	5.12 <i>E-8</i>	5.64 <i>E-7</i>	6.21 <i>E-6</i>	6.83 <i>E-5</i>	7.51 <i>E-4</i>	8.26 <i>E-3</i>	9.09 <i>E-2</i>	1.00
Second-order upwind	0	-3.46 <i>E-10</i>	-3.57 <i>E-10</i>	3.34 <i>E-9</i>	6.59 <i>E-8</i>	1.05 <i>E-6</i>	1.65 <i>E-5</i>	2.59 <i>E-4</i>	4.07 <i>E-3</i>	6.38 <i>E-2</i>	1.00
Second-order central	0	-4.41 <i>E-2</i>	2.21 <i>E-2</i>	-7.72 <i>E-2</i>	7.17 <i>E-2</i>	-1.52 <i>E-1</i>	1.83 <i>E-1</i>	-3.19 <i>E-1</i>	4.35 <i>E-1</i>	-6.96 <i>E-1</i>	1.00
QUICK	0	1.06 <i>E-5</i>	1.27 <i>E-4</i>	-2.28 <i>E-4</i>	9.22 <i>E-4</i>	-2.79 <i>E-3</i>	9.21 <i>E-3</i>	-2.96 <i>E-2</i>	9.58 <i>E-2</i>	-3.09 <i>E-1</i>	1.00

TABLE IIIc
 Numerical Solutions to Test Problem I (11 Grid Points, $p_{e, dx} = 100$)

Method	ϕ_1	ϕ_2	ϕ_3	ϕ_4	ϕ_5	ϕ_6	ϕ_7	ϕ_8	ϕ_9	ϕ_{10}	ϕ_{11}
Eq. (11)	0	0	0	0	0	0	0	0	0	0	1.00
First-order upwind	0	1.05 <i>E-16</i>	1.01 <i>E-15</i>	3.19 <i>E-15</i>	1.45 <i>E-12</i>	9.69 <i>E-11</i>	9.61 <i>E-9</i>	9.71 <i>E-7</i>	9.80 <i>E-5</i>	9.90 <i>E-3</i>	1.00
Second-order upwind	0	-5.05 <i>E-11</i>	-9.06 <i>E-11</i>	-1.40 <i>E-10</i>	-2.11 <i>E-10</i>	-3.03 <i>E-10</i>	1.47 <i>E-9</i>	2.92 <i>E-7</i>	4.41 <i>E-5</i>	6.64 <i>E-3</i>	1.00
Second-order central	0	-4.15	1.69 <i>E-1</i>	-4.32	3.53 <i>E-1</i>	-4.52	5.52 <i>E-1</i>	-4.72	7.67 <i>E-1</i>	-4.95	1.00
QUICK	0	2.46 <i>E-5</i>	2.51 <i>E-3</i>	-2.65 <i>E-3</i>	8.94 <i>E-3</i>	-1.70 <i>E-2</i>	4.09 <i>E-2</i>	-8.85 <i>E-2</i>	2.01 <i>E-1</i>	-4.46 <i>E-1</i>	1.00

The numerical solutions to this test problem by the combination of Eq. (1) and each of the schemes described in Eq. (2) to Eq. (5) for different values of cell Peclet number are contained in Tables IIIa-c. For $p_{e \Delta x} = u \Delta x / \nu = 0.2$ the solutions by QUICK and the second-order central differencing are the most accurate while that by the second-order upwind is also very acceptable. For $p_{e \Delta x}$ less than 1, the Fourier components with the wavenumber equal to or larger than k_{\max} are not crucial for ϕ in (11), and the leading truncation error term of a finite difference approximation is representative of the order of total numerical error. In Table IIIa the first-order upwind yields the solution with the largest error due to the introduction of the numerical viscosity (see Table I) to the second derivative term in Eq. (7). It is noted that among the four different schemes described in Eqs. (2) to (5), only the first-order upwind always gives a diagonally dominant coefficient matrix for the set of difference equations. For $p_{e \Delta x} = 10$ and 100, both QUICK and the second-order central differencing show solutions with wiggles; the magnitudes of this spurious oscillation in the solution by the second-order central differencing are generally much larger than those by QUICK. Yet, throughout the whole range of $p_{e \Delta x}$, the solutions by both the first-order upwind and the second-order upwind schemes are wiggles-free. This may be analyzed via studying the roots of the characteristic equation associated with a specific scheme. For example, if QUICK is used, the resulting finite difference equation for Eq. (7) at the grid point i is

$$\frac{p_{e \Delta x}}{8} \phi_{i-2} - (1 + \frac{7}{8} p_{e \Delta x}) \phi_{i-1} + (2 + \frac{3}{8} p_{e \Delta x}) \phi_i - (1 - \frac{3}{8} p_{e \Delta x}) \phi_{i+1} = 0. \quad (12)$$

The exact solution of Eq. (12) is given by [21, Sect. 8.5.1]

$$\phi_i = \gamma_1 Z_1^{i-1} + \gamma_2 Z_2^{i-1} + \gamma_3 Z_3^{i-1}, \quad (13)$$

where Z_1 , Z_2 , and Z_3 are zeros of the characteristic equation

$$\frac{p_{e \Delta x}}{8} Z^3 - (1 + \frac{7}{8} p_{e \Delta x}) Z^2 + (2 + \frac{3}{8} p_{e \Delta x}) Z - (1 - \frac{3}{8} p_{e \Delta x}) = 0. \quad (14)$$

These zeros are

$$Z_1 = 1, \quad Z_{2,3} = \frac{\left(1 + \frac{3}{4} p_{e \Delta x}\right) \pm \sqrt{\left(1 + \frac{3}{4} p_{e \Delta x}\right)^2 - \frac{p_{e \Delta x}}{2} \left(1 - \frac{3}{8} p_{e \Delta x}\right)}}{2 \left(1 - \frac{3}{8} p_{e \Delta x}\right)}. \quad (15)$$

The constants γ_1 , γ_2 , and γ_3 are determined by the two boundary conditions $\phi_1 = 0$, $\phi_{N+1} = 1$, and the value of ϕ_2 which is calculated by a starting calculation method.

To compute ϕ_2 the first-order upwind scheme may be used for both QUICK and the second-order upwind schemes; it is found that, for this specific problem, the solutions obtained in this way are comparable with other more accurate strategies such as the one which will be discussed later on for the flow problem with a source term.

Equation (14) shows that, for the problem considered, QUICK gives the solutions with wiggles for $p_{e \Delta x} > 8/3$; this is because one of the roots in Eqs. (15) is of the negative sign for $p_{e \Delta x} > \frac{8}{3}$. Here $p_{e \Delta x} = \frac{8}{3}$ is called the critical cell Peclet number for QUICK. Table IV shows the roots of the characteristic equations and the values of the critical cell Peclet number associated with the various schemes for the test problem I. Those roots of both the first-order upwind and the second-order upwind are always positive; the solutions for the model problem by the two schemes are wiggle-free. The critical cell Peclet number for the second-order central

TABLE IV
Roots of Eq. (13) Using Four Different Schemes

Scheme	Roots	Critical Value of $p_{e \Delta x}$
First-order upwind	$1 + p_{e \Delta x}$ 1	∞
Second-order upwind	$\frac{\left(1 + \frac{3p_{e \Delta x}}{2}\right) \pm \sqrt{\left(1 + \frac{3p_{e \Delta x}}{2}\right)^2 - 2p_{e \Delta x}}}{2}$ 1	∞
Second-order central	$1 + \frac{p_{e \Delta x}}{2}$ $1 - \frac{p_{e \Delta x}}{2}$ 1	2
QUICK	$\frac{\left(1 + \frac{3p_{e \Delta x}}{4}\right) \pm \sqrt{\left(1 + \frac{3p_{e \Delta x}}{4}\right)^2 - \frac{p_{e \Delta x}}{2} \left(1 - \frac{3p_{e \Delta x}}{8}\right)}}{2 \left(1 - \frac{3}{8} p_{e \Delta x}\right)}$ 1	$\frac{8}{3}$

differencing is, as is well known, 2. When $p_{e \Delta x}$ is far larger than unity the two characteristic roots of the second-order central differencing are very close to each other in magnitude. Hence, as was shown by Gresho and Lee [22], the magnitudes of the oscillation in the solution are dependent upon whether the total number of mesh points is even or odd. It should be emphasized that, while both second-order central differencing and QUICK produce the solutions with wiggles, there are some differences between these two methods. As the Peclet number is increased, the wiggles produced by central differencing are more serious than those produced by QUICK. Nevertheless, it is clear that, for this model problem, with high values of $p_{e \Delta x}$, neither the second-order central differencing nor QUICK will be very satisfactory; the higher-order terms in the modified equations cannot increase the weight of the diffusion term adequately to balance the convection term in the boundary layer without letting the disturbances propagate into the main region; therefore, the numerical solutions oscillate. On the other hand, the solutions by both the first-order upwind and the second-order upwind schemes are wiggle-free and acceptable; the second-order upwind scheme produces more accurate simulations than the first-order one for the whole range of $p_{e \Delta x}$. Hence, the truncation errors in these two schemes are able to help damp out the disturbances where needed more effectively than those in QUICK and the second-order central differencing.

It is noted that Tables I and II, which show the effects of leading truncation error terms, seem to suggest that second-order central differencing and QUICK are favorable and the two upwind differencing unfavorable for high cell Peclet number

designed only to demonstrate the difficulty all the methods have in handling high-wavenumber variations. To judge which of the methods is better, based on a Fourier analysis, one must extend the modified equation (5) to consider the higher-order derivative terms. This cannot be done analytically. An analysis such as the one presented in this section may be more appropriate. It is clear by comparing Tables I, II, and IV that the formal order of accuracy loses its meaning for high $p_{e \Delta x}$ numerical simulation since the leading truncation error term no longer represents the real size of the numerical error. For a low $p_{e \Delta x}$ flow, however, the formal order of accuracy is still a good basis to judge the relative accuracy between two schemes with different order, e.g., the first-order upwind and QUICK.

Another aspect concerning the validity of the numerical solutions with large values of the cell Peclet number which is worth commenting on is that no scheme is accurate if a quantity such as ϕ_x is to be calculated at the right-hand boundary point for this model problem. This is, again, due to the fact that the high-wavenumber Fourier components, which are important at the right-hand boundary for high $p_{e \Delta x}$ flow, cannot be evaluated accurately in the course of the numerical approximations by a finite difference scheme. Here, $\phi_{N+1} = 1$ and the smallest value of ϕ_N that one would like to see is zero (otherwise the wiggles start to appear). Hence, the numerical calculation for ϕ_x at $x = 1$ is, at best, $(\phi_{N+1} - \phi_N)/\Delta x = 1/\Delta x$. This result is independent of the Peclet number, contrasting to that which is obtained from the analytical solution which increases directly with $p_{e \Delta x}$ [22].

Test Problem II: Flow with Source Term

Leonard [9] chose the model problem

$$u\phi_x = v\phi_{xx} + S(x), \quad u, v = \text{constants} > 0, \tag{16a}$$

$$\phi(0) = 0, \tag{16b}$$

$$(\phi_x)_{x=L} = 0 \tag{16c}$$

to study the accuracy of the finite difference approximation to high $p_{e \Delta x}$ flow in the presence of a source term. Further investigation is given here for the same problem by varying the distribution of $S(x)$ to determine the limit of an adequate numerical simulation as well as to compare the performances among different schemes. The basic form of $S(x)$ used here is

$$\begin{aligned}
 S(x) &= ax + b, & 0 \leq x \leq x_1, \\
 &= -\frac{(ax_1 + b)}{x_2}x + \frac{(x_1 + x_2)}{x_2}(ax_1 + b), & x_1 \leq x \leq x_1 + x_2,
 \end{aligned}
 \tag{17}$$

as is shown in Fig. 2.

For the extreme case of $p_{e \Delta x} \rightarrow \infty$, Leonard [9] has shown that the solutions given by QUICK are much better than those by the first-order upwind which follow closely the exact solution of $p_{e \Delta x} = 2$, and those by the second-order central differencing which are more susceptible to changes in the downstream boundary condition; here we concentrate on the comparisons between the solutions by the second-order upwind and by QUICK schemes for $p_{e \Delta x} = 10^8$. In Figs. 3 the influences of the in-flow and out-flow boundary conditions on the numerical accuracy are investigated. In Figs. 4, the high-wavenumber variation effects of the source term will be studied.

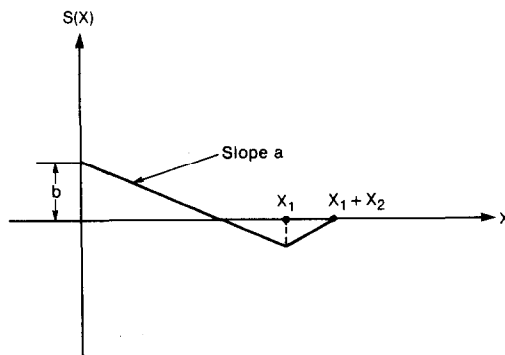

FIG. 2. Distribution of source term in Eq. (17).

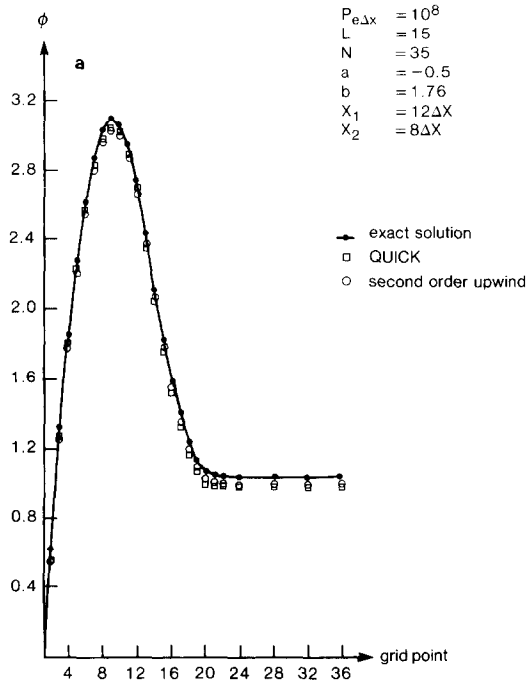

FIG. 3a. Numerical solutions to test problem II (downstream boundary condition: $d\phi/dx=0$). Starting calculation method: $\phi_1 = \phi(0) = 0$, ϕ_2 by first-order upwind.

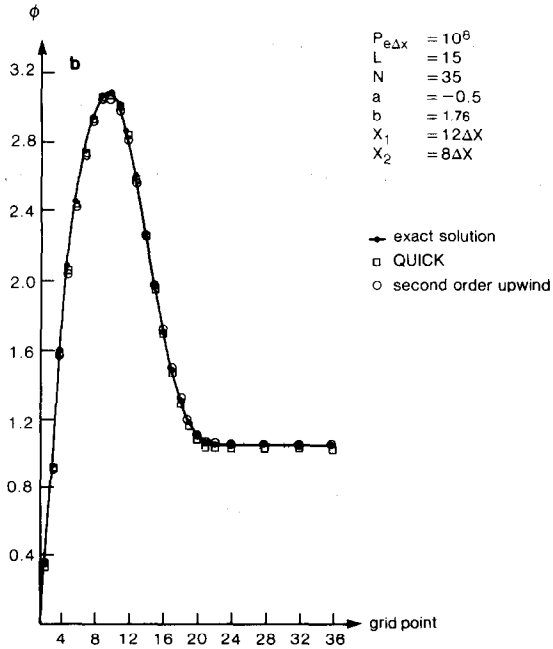

FIG. 3b. Numerical solutions to test problem II (downstream boundary condition: $d\phi/dx=0$). Starting calculation method: $\phi_1 = \phi(-\Delta x/2) = -\phi_2$, ϕ_2 by first-order upwind.

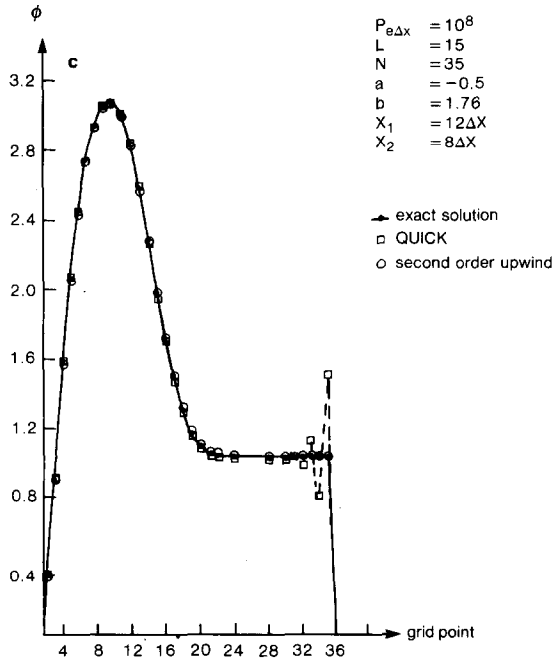

FIG. 3c. Numerical solutions to test problem II (downstream boundary condition: $\phi = 0$). Starting calculation method: $\phi_1 = \phi(-\Delta x/2) = -\phi_2$, ϕ_2 by first-order upwind.

For a source spanning through several mesh lengths, both schemes can give accurate solutions for $p_{e\Delta x} \rightarrow \infty$; the only thing that should be handled carefully is the strategy for the starting calculation. Figure 3a show the solutions calculated by both schemes using the first-order upwind scheme to calculate the first unknown value of the dependent variable, ϕ_2 . Figure 3b shows the solutions by both schemes putting the left-hand boundary point, $x = 0$, in the middle of the first numerical mesh interval and assigning the value of ϕ at the first grid point, ϕ_1 , by linearly extrapolating the values of ϕ_2 (which is located at $x = \Delta x/2$) and the boundary value at $x = 0$. Here, $\phi = 0$ at $x = 0$, hence $\phi_1 = -\phi_2$. The solutions calculated in this way, as was suggested by Leonard [9], are more accurate than those shown in Fig. 3a for both schemes. Also, in both Figs 3a and b, the accuracy of the solutions by the two schemes are comparable. An interesting study concerning the treatment of boundary points can be found in [23]. Figure 3c shows what changes are produced in the numerical results if $\phi = 0$, not $\phi_x = 0$, is used as the downstream boundary condition. For this example, the solution by the second-order upwind scheme is more satisfactory than that by QUICK. The restraint imposed by the boundary condition at the downstream end forces the numerical solution by QUICK to show oscillations because the higher-order terms in the modified equation fail to help damp out the disturbances in that thin layer.

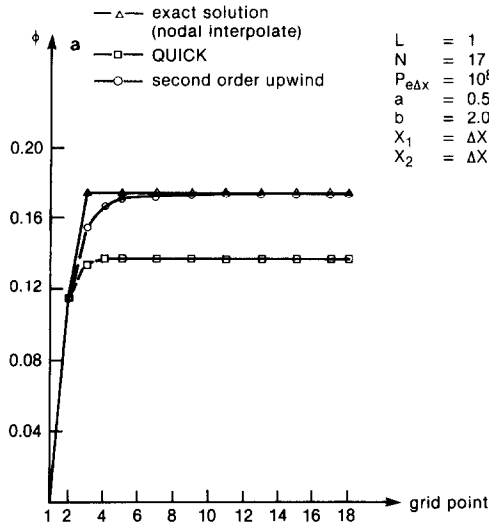

FIG. 4a. Numerical solutions to test problem II (downstream boundary condition: $d\phi/dx=0$). Starting calculation method: $\phi_1 = \phi(0) = 0$, ϕ_2 by first-order upwind.

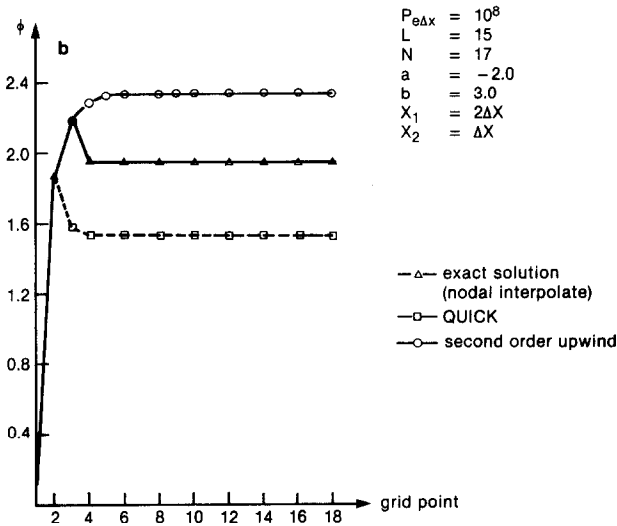

FIG. 4b. Numerical solutions to test problem II (downstream boundary condition: $\phi = 0$). Starting calculation method: $\phi_1 = \phi(0) = 0$, $\phi_2 = \phi(\Delta x) = \text{exact solution}$.

Figure 4a compares the two numerical solutions with the exact solution for a faster varying source term spanning through two mesh lengths. Neither of the two numerical solutions is totally accurate for all grid points but the one by second-order upwind is better. Figure 4b shows the numerical solutions by the two schemes against the exact solution for a more stringent source distribution. For this problem the Fourier components with the wavenumber equal to or higher than $\pi/\Delta x$ are important to the exact solution, and, as was discussed previously, they cannot be resolved satisfactorily by the finite difference approximations; the solutions by both schemes carry unacceptably large errors even when the exact value of ϕ_2 is assigned to eliminate any error involved in the starting calculation method. This demonstrates well the fact that any attempt to accurately simulate a flow with the length scale $2\Delta x$ (or less) is out of the question; a more refined mesh must be used for all schemes considered here. On the other hand, for a problem with mild source distribution and downstream boundary condition such as that shown in Fig. 3b, an accurate numerical approximation is possible for large $pe\Delta x$ because the diffusion term in Eq. (16a) plays no important role in the whole flow region.

5. TEST PROBLEM III: TWO-DIMENSIONAL FLOW

To study the problem of the numerical diffusion in a multi-dimensional flow, the following idealized case is considered first:

$$u\phi_x + v\phi_y = 0, \quad 0 \leq x \leq 1, 0 \leq y \leq 1, \quad (18a)$$

$$\phi(0, y) = 100y^n, \quad 0 \leq y \leq 1, \quad (18b)$$

$$\phi(x, 0) = 100 \left(\frac{x}{\cot \theta} \right)^n \quad 0 \leq x \leq 1, \quad (18c)$$

where $\cot \theta = u/v$, and u and v are positive constants. The difference between the first-order upwind and the skew upwind schemes [10] is analyzed here to show some basic characteristics of the numerical diffusion. The first-order upwind approximation to Eq. (18a) at the grid point (i, j) may be written as follows:

$$\phi_{i,j} = \phi_{i-1,j} + \frac{\alpha}{1+\alpha} (\phi_{i,j-1} - \phi_{i-1,j}), \quad (19a)$$

where

$$\alpha = \frac{v \Delta x}{u \Delta y}. \quad (19b)$$

Equation (19a) shows that ϕ_{ij} is calculated by linearly interpolating between $\phi_{i-1,j}$ and $\phi_{i,j-1}$ at the point where the straight line connecting the grid points $(i-1, j)$ and $(i, j-1)$ intersects the velocity vector at the point (i, j) . It is known that when convection dominates in establishing the spatial distribution of the quantity ϕ , the

directional derivative of ϕ in the streamwise direction vanishes, and the cross-flow derivative depends on the upstream boundary conditions. From Eq. (19a) it is clear that the first-order upwind gives the exact solution if the exponent n in Eqs. (18b, c) is unity; otherwise, the error resulting from the linear interpolation in Eq. (19a) will cause numerical diffusion in the cross-stream direction. With this recognition, Raithby [10] devised the following scheme to approximate Eq. (18a) more closely:

$$u \frac{\phi_{i+1/2,j} - \phi_{i-1/2,j}}{\Delta x} + v \frac{\phi_{i,j+1/2} - \phi_{i,j-1/2}}{\Delta y} = 0, \tag{20a}$$

where

$$\phi_{i+1/2,j} = \phi_{i,j} - (\phi_{i,j} - \phi_{i,j-1}) \frac{\alpha}{2}, \tag{20b}$$

$$\phi_{i-1/2,j} = \phi_{i-1,j} - (\phi_{i-1,j} - \phi_{i-1,j-1}) \frac{\alpha}{2}, \tag{20c}$$

$$\phi_{i,j+1/2} = \phi_{i,j} - (\phi_{i,j} - \phi_{i-1,j}) \frac{1}{2\alpha}, \tag{20d}$$

$$\phi_{i,j-1/2} = \phi_{i,j-1} - (\phi_{i,j-1} - \phi_{i-1,j-1}) \frac{1}{2\alpha}. \tag{20e}$$

Equation (20a) can be rewritten as follows:

$$\phi_{i,j} = \phi_{i-1,j-1} + \frac{1-\alpha}{1+\alpha} (\phi_{i-1,j} - \phi_{i,j-1}). \tag{21}$$

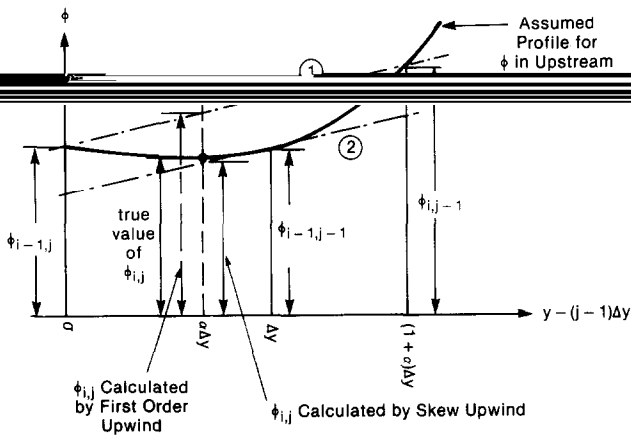

FIG. 5. Comparison of accuracy between first-order upwind and skew upwind approximations to Eq. (18a) (lines 1 and 2 are parallel).

Figure 5 compares the way to calculate $\phi_{i,j}$ by the first-order upwind scheme with that by the skew upwind scheme. It can be seen that, although both schemes are formally exact only for a linear variation of the ϕ profile in the cross-stream direction, the $\phi_{i,j}$ calculated by the skew upwind scheme can be a substantial improvement over that calculated by the first-order upwind scheme. As to the second-order upwind and QUICK schemes, both are exact for a quadratic profile of ϕ in the cross-stream direction.

Figure 6 shows the numerical solutions to Eqs. (20) by the four schemes: first-order upwind, skew upwind, second-order upwind, and QUICK, for $n=2$ and $\cot \theta = 2$. The skew upwind scheme is used to calculate the first unknowns from the upstream boundaries for both the second-order upwind and QUICK. In addition, the downstream boundary conditions are also needed by QUICK and the skew upwind scheme is also used there. In Fig. 6, the grid points connected by any single streamline should possess the same value of ϕ . While the first-order upwind scheme gives solutions with some noticeable numerical cross-stream diffusion, all other three schemes give very good approximations. It is noted that the small errors appearing in the solution by QUICK are caused by the calculation for the downstream boundary values. Figure 6 demonstrates that the first-order skew

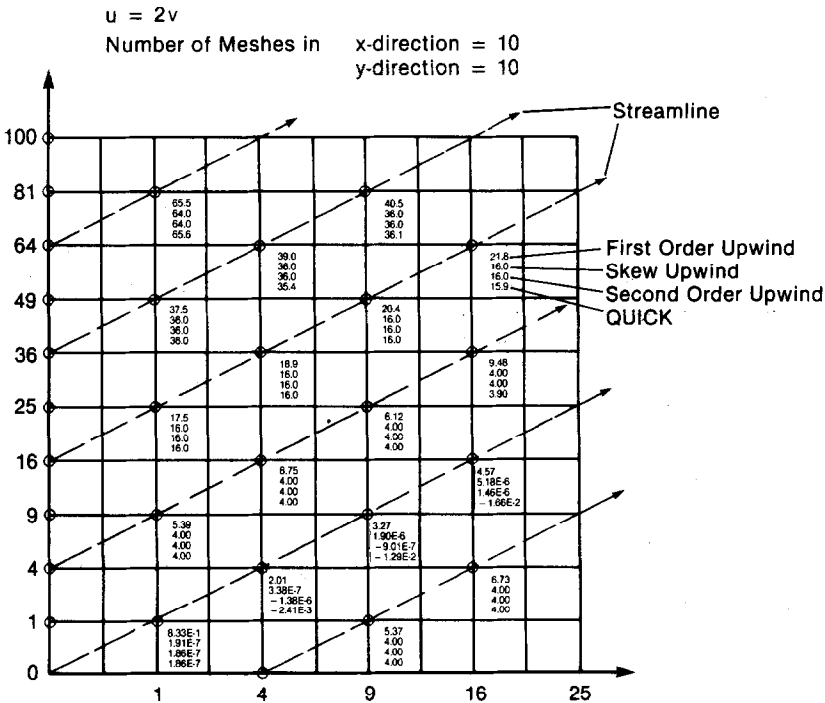

FIG. 6. Numerical solutions to Eq. (18) for $n=2$.

Number of Meshes in x-direction = 10
 y-direction = 10

$u = 2v$

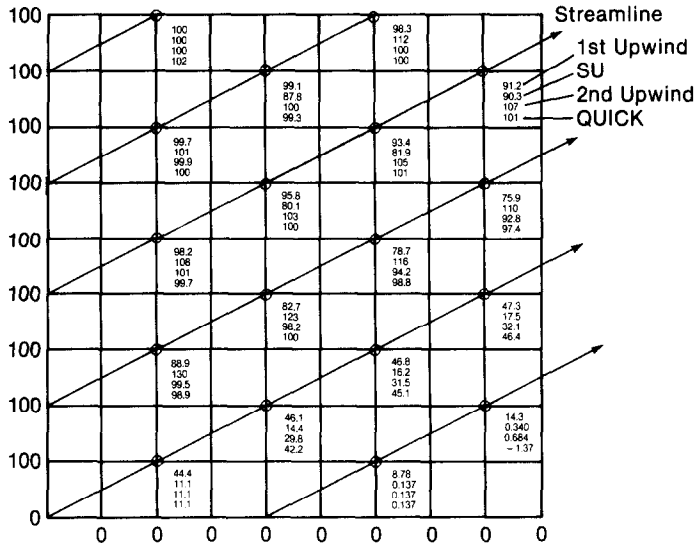

FIG. 7. Numerical solutions to Eq. (18) (upstream boundary conditions: $\phi(0, y) = 100, 0 < y \leq 1,$
 $\phi(x, 0) = 0, 0 \leq x \leq 1$).

upwind differencing can reduce the cross-stream numerical diffusion substantially. Figure 7 shows the numerical solutions by the four schemes for the same equation but with a more stringent upstream boundary condition; a step function, instead of an n th-power polynomial, is used. Here, again, because of the importance of the high-wavenumber Fourier components to the real solution, no scheme is able to give a very accurate approximation; the sharp variation in the real solution is smeared out due to the numerical diffusion. Also, the solutions by the skew upwind, second-order upwind, and QUICK schemes all exhibit over-shoots; the solution by QUICK also exhibits under-shoot. Globally speaking, QUICK and the second-order upwind schemes perform better here.

After examining the possible error caused by the numerical approximations to the convection terms, a two-dimensional flow problem including both convection and diffusion terms, as stated in the following, is considered next:

$$u\phi_x + v\phi_y = v(\phi_{xx} + \phi_{yy}), \quad 0 \leq x \leq 1, 0 \leq y \leq 1, \quad (22a)$$

$$\phi(0, y) = 100, \quad 0 < y \leq 1, \quad (22b)$$

$$\phi(x, 0) = 0, \quad 0 \leq x \leq 1, \quad (22c)$$

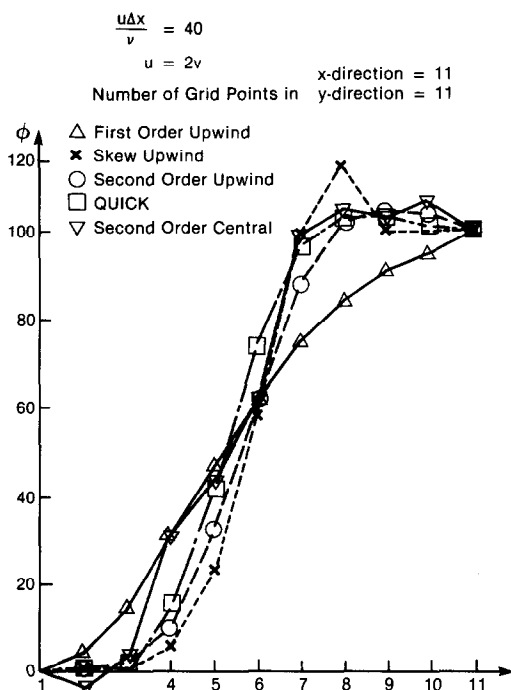

FIG. 8. Numerical solutions to Eq. (21) at $x = 1 - 2 \Delta x$ (downstream boundary conditions: zero differences between upstream and downstream boundary values).

where u and v are positive constants; the parameters $u/v = 2$, and cell Peclet number based on $u \Delta x/\nu = 40$ are used in the study. Two different downstream conditions are investigated. (1) Convection of the upstream values along the streamlines, i.e., $\phi(x, 1) = 100$ for $0 \leq x \leq 1$; $\phi(1, y) = 0$ for $0 \leq y < \frac{1}{2}$, $\phi(1, y) = 100$ for $\frac{1}{2} < y \leq 1$, and $\phi(1, \frac{1}{2}) = 50$. This type of boundary condition has been used by Raithby [10]. (2) Zero value of ϕ along all the downstream boundary. Five numerical schemes, first-order upwind, skew upwind, second-order central differencing, second-order upwind, and QUICK, are compared in this test problem.

For the first kind of downstream boundary condition, i.e., the zero differences between the upstream and the downstream boundary values along a streamline, a typical profile of ϕ , plotted as a function of y at $x = 1 - 2 \Delta x$, given by the numerical approximations is shown in Fig. 8. The profile by the first-order upwind is the smoothest one due to the excessive numerical diffusion. The solution by the second-order central differencing, on the other hand, shows wiggles in the flow region. The other three schemes all produce solutions with a limited amount of over-shoot near the downstream boundary. Among them, the solutions by QUICK and by the second-order upwind scheme are more satisfactory. The difference between the true solution for the first kind of boundary condition and the true

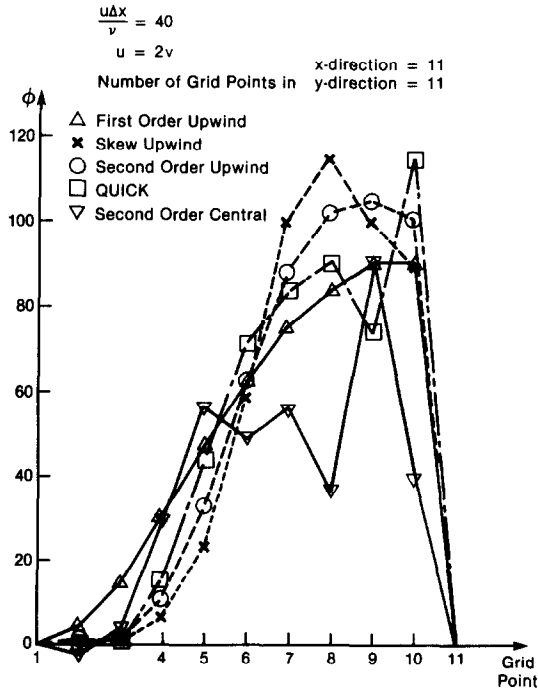

FIG. 9. Numerical solutions to Eq. (21) at $x = 1 - 2 \Delta x$ (downstream boundary conditions: $\phi = 0$).

solution for the second kind of downstream boundary condition, i.e., $\phi = 0$, for high $p_e \Delta x$ flow should be of the character that a boundary layer region is formed in the vicinity of the downstream boundary, with the solution in the main region of the flow field basically the same. The solutions by the five numerical schemes for this problem are compared in Fig. 9. Those by the second-order central differencing and by QUICK show unacceptably large magnitude of oscillation. The solutions by the three upwind schemes are, compared to those in Fig. 8, unaffected by the change of the boundary condition except for the points in the far downstream. In this case, the best scheme is the second-order upwind, which shows a reasonable compromise between an accurate simulation in the convection-dominated region and an effective enhancement to the diffusion term in the boundary layer region which prevents the disturbances from propagating.

6. SUMMARY AND CONCLUSIONS

Five different finite difference schemes, first-order upwind, skew upwind, second-order upwind, second-order central differencing, and QUICK, approximating the convection terms in the equation governing fluid motion, have been studied. It is

shown that in a finite difference simulation with large cell Peclet number, the high-wavenumber Fourier components of the real solutions cannot be evaluated accurately. As a result of this, in a convection-dominated flow, if the viscous terms are required to balance the convection terms in a thin layer close to the downstream boundary due to, for example, a Dirichlet-type boundary condition being applied there, a finite difference approximation can, at best, use the truncation errors of the approximations to help damp out the disturbances in that thin layer. The detailed structure of the real solution is unresolved. Even this may or may not be accomplished by a given scheme, and hence for high cell Peclet number flow the formal order of accuracy is a poor criterion to judge the performances among different schemes.

Among all of the five schemes tested in this study, the second-order upwind scheme gives the most satisfactory results in general; this scheme has been found, however, to still exhibit over-shoot in the solution to a limited extent. On the other hand, although both the second-order central differencing and QUICK are formally of the same order of accuracy as the second-order upwind, they fail to enhance the viscous terms properly in the region where needed for a high cell Peclet number flow problem, and noticeable spurious oscillations in the numerical solutions appear. It should be noted that the magnitudes of those spurious oscillations in the solutions by QUICK are generally less serious than those by the second-order central differencing. Furthermore, if no boundary layer region exists in the real solution, the accuracy of the approximating solutions given by QUICK and that by the second-order upwind scheme are comparable. As to the first-order upwind scheme, it is free from producing the unphysical over- and under-shoots in the solutions for all the test problems, but it fails to give accurate approximations in the presence of a source term [9] and shows too much numerical diffusion in the convection-dominated region for a multi-dimensional flow. The skew upwind

cross-stream direction substantially, but it is found to be less satisfactory than the second-order upwind scheme. The skew upwind scheme also fails to give accurate solutions in the presence of source terms [10].

ACKNOWLEDGMENT

Sincere thanks are due to Carol Cowser for her very skillful typing.

REFERENCES

1. A. THOM AND C. J. APELT, "Field Computation in Engineering and Physics," Van Nostrand, London, 1961.
2. O. R. BURGGRAB, *J. Fluid Mech.* **24** (1966), 113.
3. A. D. GOSMAN, W. M. PUN, A. K. RUNCHAL, D. B. SPALDING, AND M. WOLFSHTEIN, "Heat and Mass Transfer in Recirculating Flows," Academic Press, London/New York, 1969.

4. J. D. BOZEMAN AND C. DALTON, *J. Comput. Phys.* **12** (1973), 348.
5. D. ALLEN AND R. SOUTHWELL, *Quart. J. Mech. Appl. Math.* **8** (1955), 129.
6. G. DEVAHL DAVIS AND G. D. MALLINSON, *Comput. & Fluids* **4** (1976), 29.
7. I. P. CASTRO, Numerical difficulties in the calculation of complex turbulent flows, in "Turbulent Shear Flows I" (F. Durst *et al.*, Eds.), p. 220, Springer-Verlag, Berlin, 1979.
8. G. D. RAITHBY, *Comput. Methods Appl. Mech. Engrg.* **9** (1976), 75.
9. B. P. LEONARD, *Comput. Methods Appl. Mech. Engrg.* **19** (1979), 59.
10. G. D. RAITHBY, *Comput. Methods Appl. Mech. Engrg.* **9** (1976), 153.
11. M. A. LESCHZINER, *Comput. Methods Appl. Mech. Engrg.* **23** (1980), 23.
12. M. A. LESCHZINER AND W. RODI, *J. Fluids Engrg.* **103** (1981), 352.
13. T. HAN, J. A. C. HUMPHREY, AND B. E. LAUNDER, *Comput. Methods Appl. Mech. Engrg.* **29** (1981), 81.
14. M. ATIAS, M. WOLFSHTEIN, AND M. ISRAELI, *AIAA J.* **15** (1977), 263.
15. M. M. GUPTA AND R. P. MANOHAR, *AIAA J.* **16** (1978), 759.
16. S. I. CHENG AND G. SHUBIN, *J. Comput. Phys.* **28** (1978), 315.
17. G. D. STUBLEY, G. D. RAITHBY, AND A. B. STRONG, *Numer. Heat Transfer* **3** (1980), 411.
18. R. D. RICHTMYER AND K. W. MORTON, "Difference Methods for Initial-Value Problems," 2nd ed., Interscience, New York, 1967.
19. C. K. CHU, Numerical methods in fluid dynamics, in "Advances in Applied Mechanics" (C.-S. Yih, Ed.), Vol. 18, p. 286, Academic Press, New York/London, 1978.
20. R. W. MACCORMACK AND H. LOMAX, Numerical solution of compressible viscous flows, in "Annual Review of Fluid Mechanics" (M. Van Dyke *et al.*, Eds.), Vol. 11, p. 289, Annual Reviews, Inc., Palo Alto, Calif., 1979.
21. G. DAHLQUIST AND A. BJÖRCK, "Numerical Methods," Prentice-Hall, Englewood Cliffs, N.J., 1974.
22. P. M. GRESHO AND R. L. LEE, Don't suppress the wiggles—they're telling you something! in "Finite Element Methods for Convection Dominated Flows" (T. J. R. Hughes, Ed.), p. 37, The American Society of Mechanical Engineers, New York, 1979.
23. F. G. BLOTTNER, *J. Comput. Phys.* **48** (1982), 246.
24. W. SHYY, *Comput. Methods Appl. Mech. Engrg.* **43** (1984), 221.